

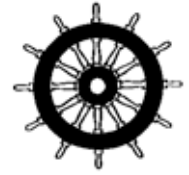

ZODIAC INTERNATIONAL
 2, Rue Maurice Mallet - 92130 ISSY Les MOULINEAUX
 France
 Fax : +33.1.41.23.23.98.
 Phone : +33.1.41.23.23.23
 E-mail : solassales@zodiac.com



BV-0062

37 MAN DAVIT LAUNCHED LIFERAFT SOLAS A & B PACK

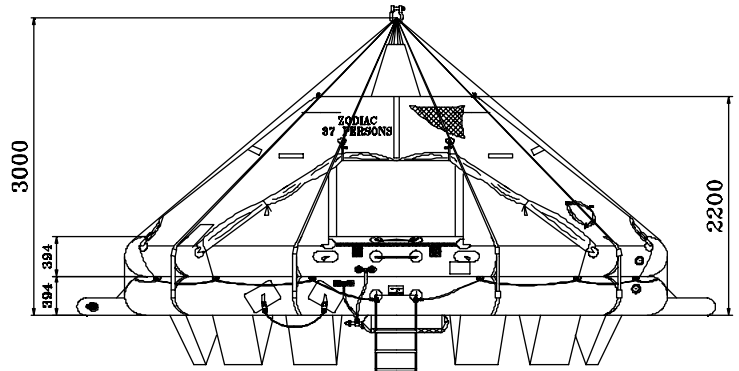
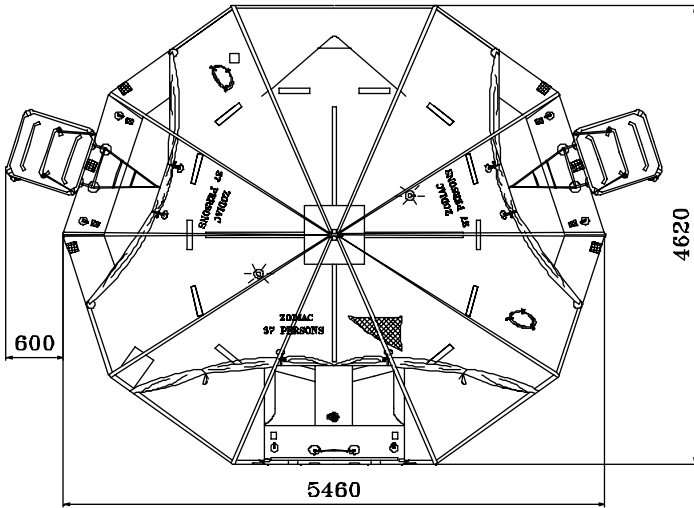

A PACK CONTAINER

B PACK CONTAINER

N17B

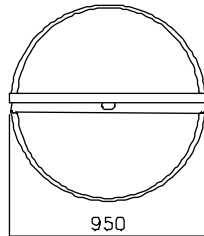
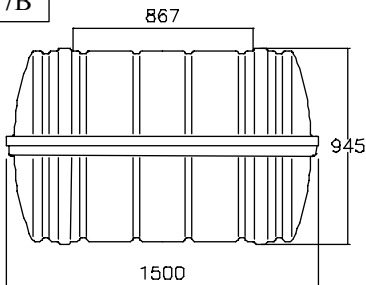

N16B

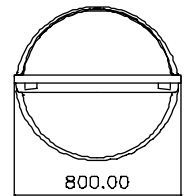
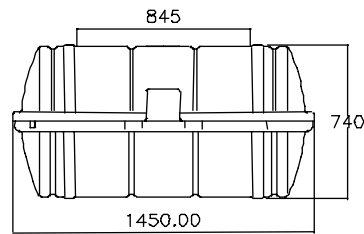

| | A PACK | | | | | B PACK | | | | |
|--|---------------|-----------|------|------|-----|---------------|-----------|-----|------|-----|
| | L | l | h | V | W | L | l | H | V | W |
| Liferaft Net weight | 281 kg | | | | | 194 kg | | | | |
| Weight loaded liferaft | 3082 kg | | | | | 2973 kg | | | | |
| Max. height of stowage | 25 meters | 36 meters | | | | 25 meters | 36 meters | | | |
| Painter line length | 35 meters | 50 meters | | | | 35 meters | 50 meters | | | |
| Inflation Cylinder | 2 x 15 liters | | | | | 2 x 15 liters | | | | |
| Holding shells line | 6 meters | | | | | 6 meters | | | | |
| Bowsing line length | 2 x 7 meters | | | | | 2 x 7 meters | | | | |
| Crate | L | l | h | V | W | L | l | H | V | W |
| L, l & h (mm), V (m ³), W (kg) | 1600 | 1050 | 1130 | 1.90 | 347 | 1525 | 850 | 900 | 1.17 | 234 |

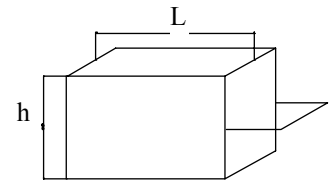

Crate

| | | |
|--------------------|---------|---------|
| Towing force | 2 knots | 3 knots |
| Without Sea anchor | 170 daN | 210 daN |
| With Sea anchor | 210 daN | 225 daN |

dimensions & weight +/- 5% (can be changed without prior notice)